

Pfaff 421 E1
Subclass

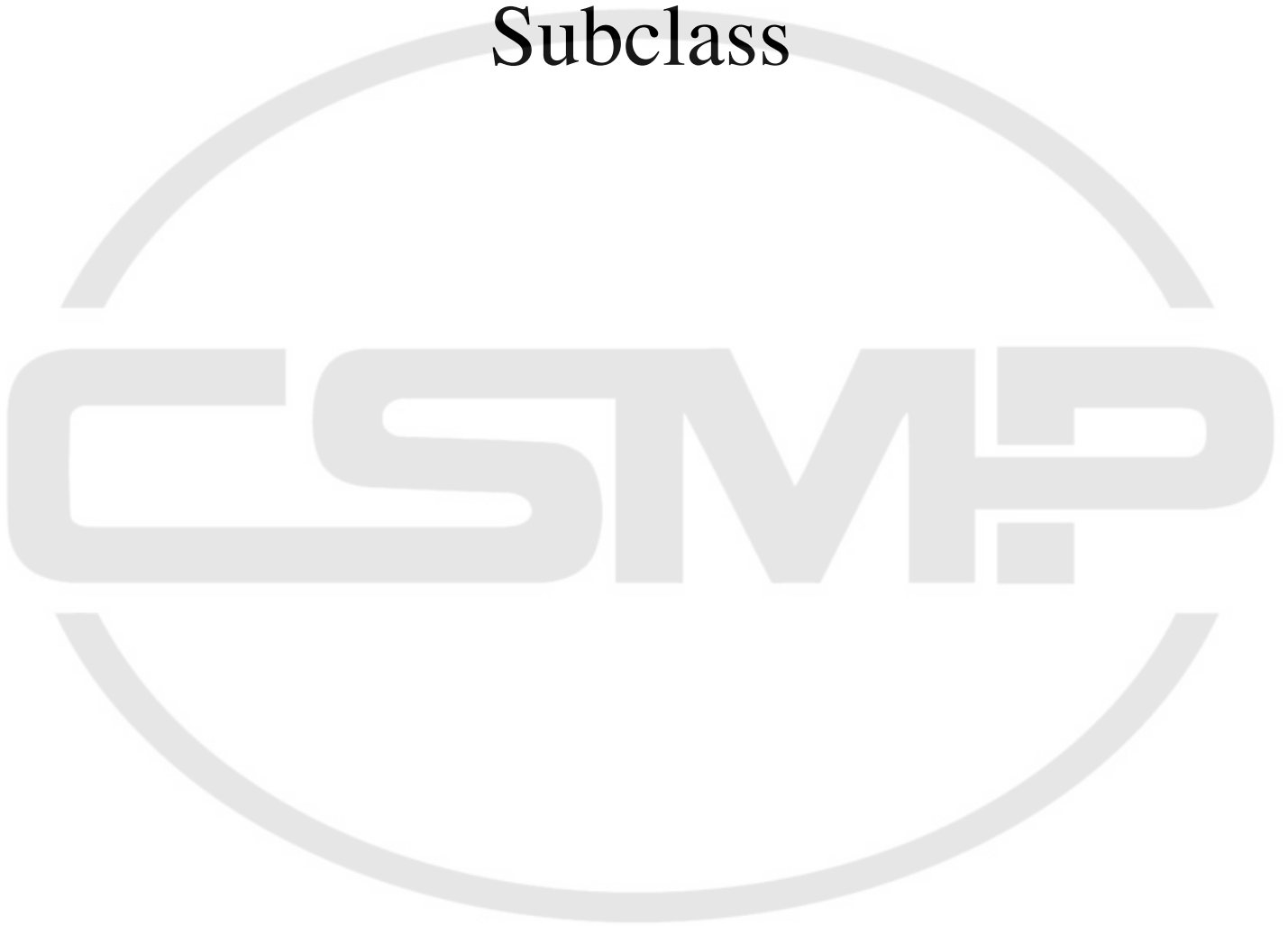

PFAFF

421 E1

Unterklassen-Ausstattung

Subclass parts

Composition des sous-classes





Composición de las subclases

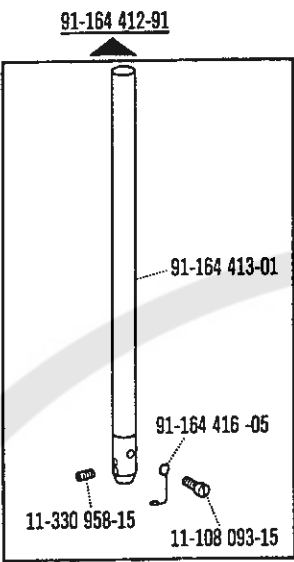

CSMP

Table of subclasses
Table des sous-classes
Tabla de subclases PFAFF 421 E1

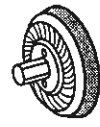
Unterklasse Subclass Sous-classe Subclase	-755/03-900/61	-755/03-900/61	-755/03-900/61
Arbeitsgang Operation Opération Operación	Zum Herstellen von Zier- und Befestigungsnähten. Schiebradtransport und angetriebener Rollfuß. For sewing fancy seams and assembly seams. Wheel feed and driven roller presser. Pour exécuter les coutures d'ornementation et de fixation. Avec entraînement par rove et pied à roulette entraînée. Para ejecutar costuras de adorno y fijación. Transportador inferior de rueda y pie rodante accionado.	Zum Herstellen von Zier- und Befestigungsnähten. Schiebradtransport und angetriebener Rollfuß. For sewing fancy seams and assembly seams. Wheel feed and driven roller presser. Pour exécuter les coutures d'ornementation et de fixation. Avec entraînement par rove et pied à roulette entraînée. Para ejecutar costuras de adorno y fijación. Transportador inferior de rueda y pie rodante accionado.	Zum Herstellen von Zier- und Befestigungsnähten. Schiebradtransport und angetriebener Rollfuß. For sewing fancy seams and assembly seams. Wheel feed and driven roller presser. Pour exécuter les coutures d'ornementation et de fixation. Avec entraînement par rove et pied à roulette entraînée. Para ejecutar costuras de adorno y fijación. Transportador inferior de rueda y pie rodante accionado.
Ausführung Model Version Tipo de máquina	AN5	BN5	B/CN5
Schneidabstand in mm Trimming margin in mm Distance de coupe en mm Margen de corte en mm			
Nadelstange Needle bar Barre à aiguille Barra de aguja	91-164 412-91	91-164 412-91	91-164 412-91
Rollfuß ⁴ Roller presser Pied à roulette Pie rodante	91-164 697-93 ^{70/9} ^{90/71}	91-164 697-93 ^{70/9} ^{90/71}	91-164 697-93 ^{70/9} ^{90/71}
Stichplatte ⁴ Needle plate Plaque à aiguille Placa de aguja	91-150 215-03	91-150 215-03	91-150 215-03
Schiebrad Feed wheel Roue d'entraînement Rueda transportadora	91-164 397-92	91-164 399-92	91-164 399-92
Lineal Edge guide Guide-droit Guía recta	09-009 851-98	09-009 851-98	09-009 851-98

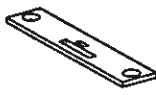
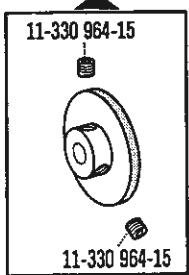
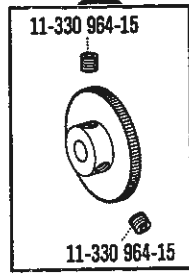
 <p>91-164 412-91</p> <p>91-164 413-01</p> <p>91-164 416-05</p> <p>11-330 958-15</p> <p>11-108 093-15</p> <p>-755/03-900/61</p>	<p>91-164 303-93 <input type="checkbox"/> A <input type="checkbox"/> 28 <input type="checkbox"/> 70/1 <input type="checkbox"/> 90/70</p>  <p>-755/03-900/61</p>	<p>91-164 502-93 <input type="checkbox"/> A <input type="checkbox"/> 28 <input type="checkbox"/> 70/6 <input type="checkbox"/> 90/70</p>  <p>-755/03-900/61</p>
<p>91-164 939-91 <input type="checkbox"/> A <input type="checkbox"/> 28 <input type="checkbox"/> 70/13 <input type="checkbox"/> 90/71</p>  <p>-755/03-900/61</p>	<p>91-164 941-91 <input type="checkbox"/> A <input type="checkbox"/> 28 <input type="checkbox"/> 70/14 <input type="checkbox"/> 90/70</p>  <p>-755/03-900/61</p>	<p>91-150 215-03 <input type="checkbox"/> A <input type="checkbox"/> B <input type="checkbox"/> B/C</p>  <p>-755/03-900/61</p>
<p>91-164 397-92 <input type="checkbox"/> A</p>  <p>11-330 964-15</p> <p>11-330 964-15</p> <p>-755/03-900/61</p>	<p>91-164 399-92 <input type="checkbox"/> B <input type="checkbox"/> B/C</p>  <p>11-330 964-15</p> <p>11-330 964-15</p> <p>-755/03-900/61</p>	

siehe Erläuterungen Register 0
 see explanations in section 0
 voir légende registre 0
 ver explicaciones del registro 0

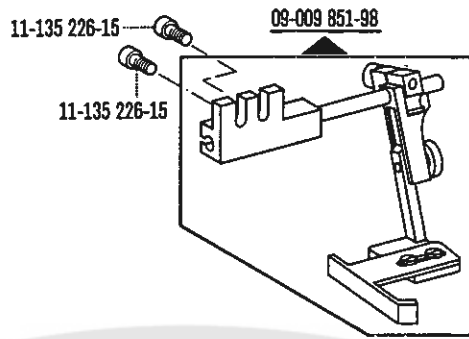

-755/03-900/61

